

# HI-LINK HLK-LD2461 USER MANUAL



## Table of Contents

- [Table of Contents](#)
- [Product Overview](#)
- [Specification Parameter](#)
- [Detect angle and distance](#)
- [RF performance](#)
- [Electrical characteristics](#)
- [Module dimensions and pin description](#)
- [Module dimensions package](#)
- [Pin description](#)
- [Use wiring diagram](#)
- [Main functions and performance](#)
- [Radar module operating range](#)
- [Main functions and performance](#)
- [Communication protocol](#)
- [Radar installation method](#)
- [Horizontal installation](#)
- [Slanting installation](#)
- [Typical application pattern](#)
- [Smart home appliance application](#)
- [Home place application](#)
- [Energy saving control application](#)
- [Announcements](#)
- [Startup time](#)
- [Effective detection range](#)
- [Radar biological detection performance](#)
- [Power](#)
- [Common problem](#)
- [Disclaimer](#)
- [Change record](#)
- [Other ManualsLib Projects](#)



**Shenzhen Hi-Link Electronic Co., Ltd.**

---

# **HLK-LD2461**

**Motion target detection and tracking module**

**User manual**

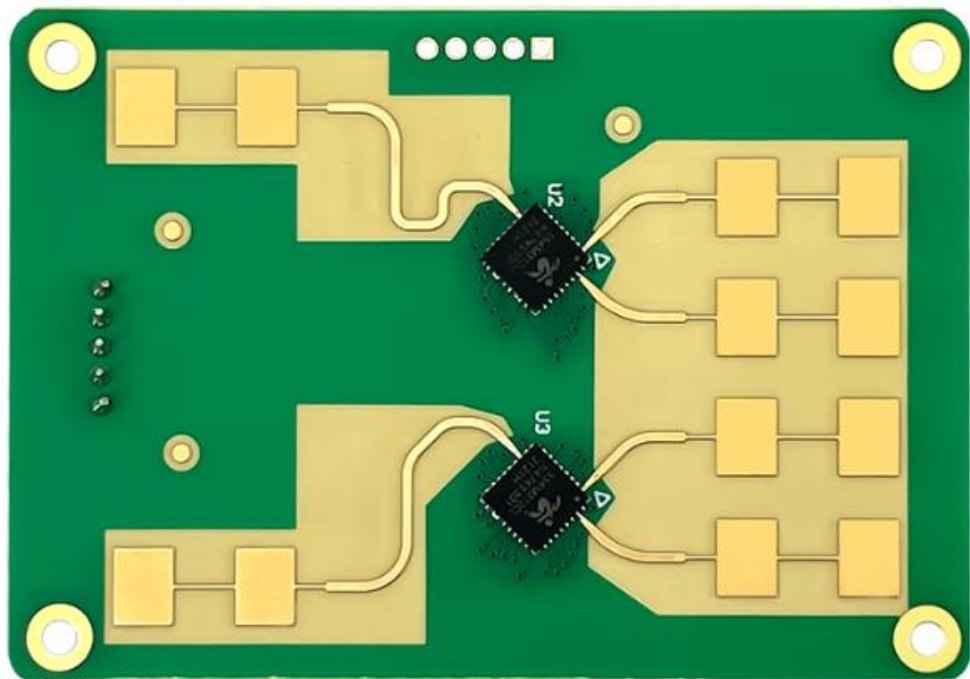

# CONTENTS

1. Product Overview .....	2
2. Specification Parameter .....	2
2.1. Detect angle and distance .....	2
2.2. RF performance .....	2
2.3. Electrical characteristics .....	3
3. Module dimensions and pin description .....	3
3.1. Module dimensions package .....	3
3.2. Pin description .....	3
3.3. Use wiring diagram .....	4
4. Main functions and performance .....	4
4.1. Radar module operating range .....	4
4.2. Main functions and performance .....	5
5. Communication protocol .....	5
6. Radar installation method .....	5
6.1. Horizontal installation .....	5
6.2. Slanting installation .....	6
7. Typical application pattern .....	7
7.1. Smart home appliance application .....	7
7.2. Home place application .....	8
7.3. Energy saving control application .....	8
8. Announcements .....	8
8.1. Startup time .....	8
8.2. Effective detection range .....	8
8.3. Radar biological detection performance .....	8
8.4. Power .....	9
9. Common problem .....	9
10. Disclaimer .....	9
11. Change record .....	9

## 1. Product Overview

HLK-LD2461 is a 24GHz millimeter wave radar product for human perception, which is composed of two 1 transmit and 2 receive millimeter wave radar chips, high-performance microstrip antenna, high-performance MCU and peripheral auxiliary circuit. The operating band is 24.00GHz to 24.25GHz, which is the ISM band. The operating bandwidth is 250MHz. This product can be used in the home, office, hotel and other scenes, to achieve a number of motion, micromotion or static human precise sensing.

## 2. Specification Parameter

### 2.1. Detect angle and distance

Parameter content	Minimum value	Typical value	Maximum value	Unit
Stationary target perceives distance	-	5	-	m
Sitting posture micro-dynamic know distance	-	6	-	m
Moving targets perceive distance	-	8	-	m
Number of supporting tracks	-	-	5	pp
Ranging accuracy	-	0.1	-	m
Resolution of ranging	-	0.75	-	m
Angular accuracy	-	2	-	°
Angular resolution	-	15	-	°
Angle of horizontal action	-45	-	45	°
Angle of pitch action	-25	-	25	°

### 2.2. RF performance

Parameter content	Minimum value	Typical value	Maximum value	Unit
Working frequency	24.0	-	24.25	GHz
Maximum sweep bandwidth	-	0.25	-	GHz
Maximum equivalent omnidirectional radiated power	-	13	-	dBm

### 2.3. Electrical characteristics

Parameter content	Minimum value	Typical value	Maximum value	Unit
Working voltage (VCC)		5.0		V
Working current (ICC)		260	400	mA
Operating temperature (TOP)	-40	-	85	°C
Storage temperature (TST)	-40	-	85	°C

## 3. Module dimensions and pin description

### 3.1. Module dimensions package

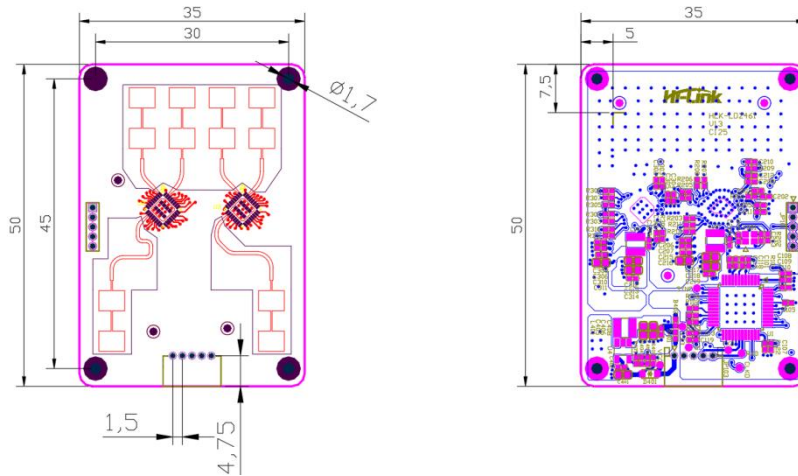
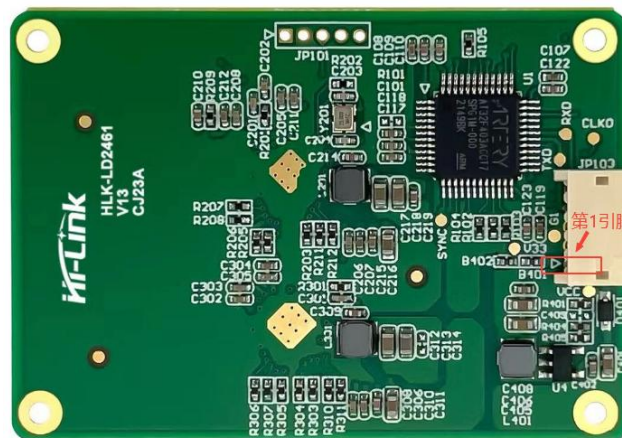

Figure 1 Schematic diagram of HLK-LD2461 radar module structure

### 3.2. Pin description



## Radar Pin Definition

Table 1 Radar Pin Definition

Pin 1	5V+
Pin 2	GND
Pin 3	GND
Pin 4	TX 【Serial write】
Pin 5	RX 【Serial read】

The symbol marked with an inverted triangle at the radar interface is pin 1. The radar is powered by pins 1 and 2. In order to receive serial port data normally, the serial port needs to be on the same ground as the radar.

### 3.3. Use wiring diagram

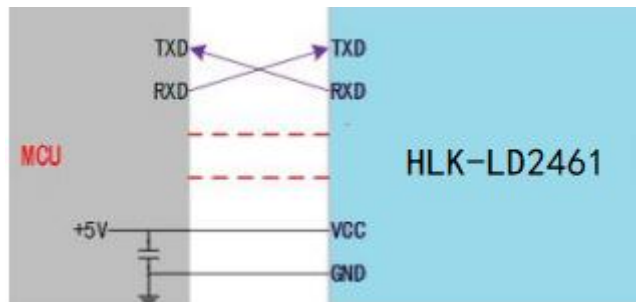

Figure 3 Schematic diagram of radar module and peripheral connection

## 4. Main functions and performance

### 4.1. Radar module operating range

The beam coverage of HLK-LD2461 radar module is shown in Figure 4. Radar coverage is a stereoscopic sector of 90° horizontal and 50° pitch.

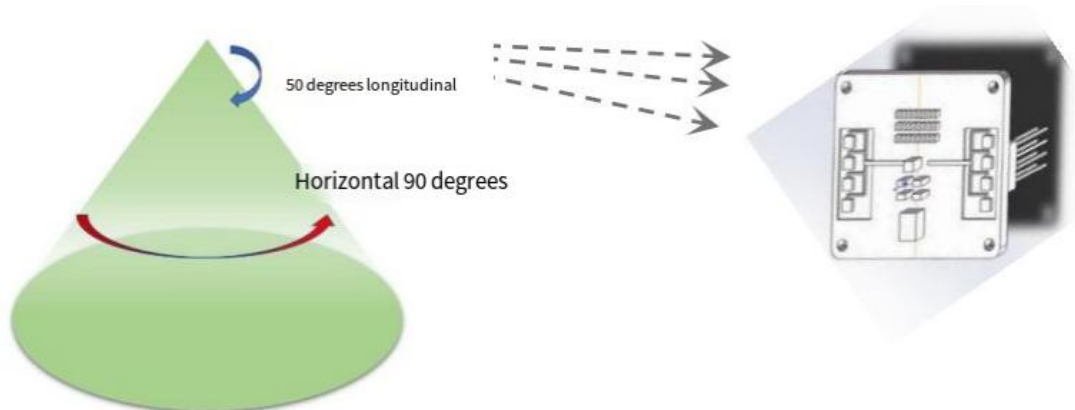

Figure 4 Schematic diagram of HLK-LD2461 radar coverage area

## 4.2. Main functions and performance

**The main functions of this radar module include:**

- A、 Motion detection:
  - a) Motion sensing distance:  $\leq 8$  meters (normal motion amplitude)
  - b) Motion trigger time:  $\leq 0.5$ s;
  - c) Accuracy rate:  $\geq 99\%$ ;
- B、 Human presence detection (breath detection):
  - a) Static body perception distance:  $\leq 6$  meters (sitting body);
  - b) Undetected maintenance time: 15s;
  - c) Accuracy rate:  $\geq 95\%$ ;
- C、 People counting:
  - a) Detection range:  $\leq 6$  meters;
  - b) Number of detectors:  $\leq 5$ ;
  - c) Accuracy rate:  $\geq 90\%$ (3)  $\geq 80\%$ (5);
- D、 Direction detection:
  - a) Identify the direction of the human body in and out, left and right, front and back;
  - b) Detection range:  $\leq 6$  meters;
  - c) Accuracy rate:  $\geq 95\%$ ;
- E、 Trajectory detection:
  - a) Identify the activity route of the human body in the detection area, so as to determine the position and direction of the human body;
  - b) Supports multi-person trajectories, enabling up to 5 people to maintain trajectories;
  - c) Detection range:  $\leq 6$  meters;
  - d) Accuracy rate:  $\geq 90\%$ ;

## 5. Communication protocol

The product outputs the monitoring status information through the serial port. The default transmission baud rate is 9600bps, the data bit is 8, the stop bit is 1, and the check bit and flow control are NONE. The length of the transmitted data is variable, depending on the number of targets detected.

See details: HLK-LD2461 Serial Communication Protocol for details.

## 6. Radar installation method

The recommended installation methods for the radar module include horizontal installation and inclined installation.

### 6.1. Horizontal installation

Figure 5 shows the horizontal installation mode, which is mainly aimed at human body detection in standing or sitting state, such as living room, home appliance application and other occasions.

The radar installation height is recommended to be 1 m ~1.5 m, the radar is installed horizontally and forward, the installation Angle is  $\leq \pm 5^\circ$ , and there is no obvious shielding and covering in front of the radar.

The radar normal direction is aligned with the main detection position to ensure that the main beam of the radar antenna covers the detection area.

In this installation mode, the maximum detection distance of moving human body is  $L3 \leq 8$  meters; The maximum distance of human fretting detection is  $L2 \leq 6$  meters.

Electromagnetic waves in the millimeter wave band have certain penetration characteristics for non-metallic substances, which can penetrate common glass and plastic materials, and may detect moving objects behind the occluder. But for thicker load-bearing walls, metal doors, etc., can not penetrate.

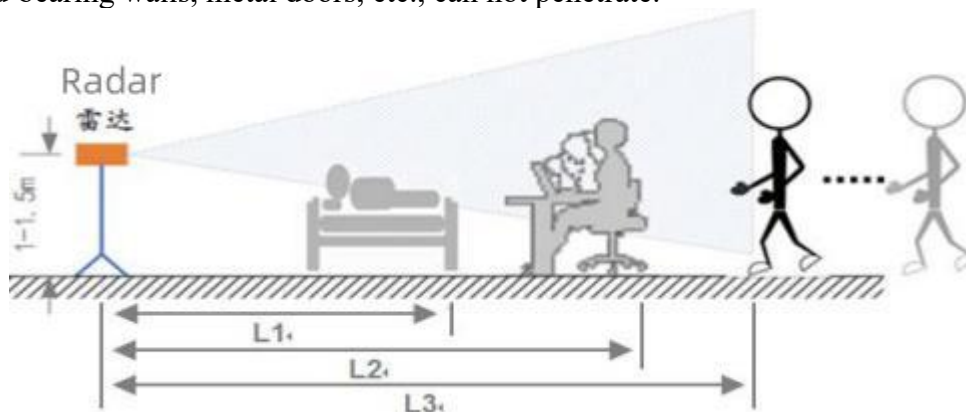

Figure 5 Horizontal installation diagram

## 6.2. Slanting installation

Figure 6 shows an inclined installation. This installation method is mainly for the detection of moving human body, mainly suitable for hotels, halls and other places.

Radar installation height is recommended to be 2-2.5 meters; The tilt Angle of the radar under view ranges from  $10^\circ$  to  $30^\circ$ , and the radar antenna surface is free of occlusions and coverings.

The radar normal direction is aligned with the main detection position to ensure that the main beam of the radar antenna covers the detection area.

In this installation mode, the maximum detection distance of moving human body is  $L3 \leq 8$  meters; The maximum distance of human fretting detection is  $L2 \leq 6$  meters.

In this mode, there may be detection blind spots directly below and near the radar.

With the increase of the down Angle, the maximum detection distance of the human body will decrease. Due to the influence of radar antenna beam radiation characteristics, the effective range of radar in illegal line direction will be reduced.

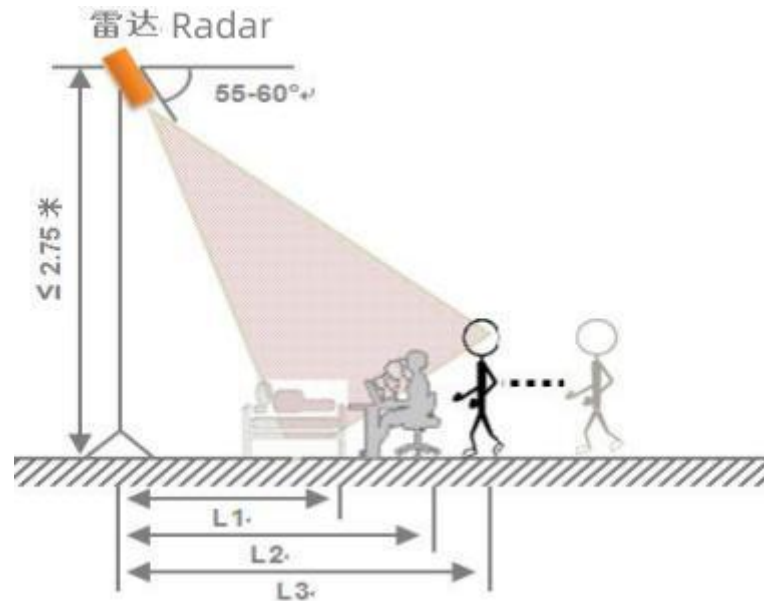

Figure 6 Oblique view of the installation diagram

## 7. Typical application pattern

### 7.1. Smart home appliance application

The radar is installed inside the home appliance and can monitor the personnel condition within the detection range of the radar in real time. According to the radar detection results (manned/unmanned), the equipment can adjust the working mode of the equipment in real time or quasi-real time (working, low power consumption, standby, shutdown, etc.) to realize the intelligent home appliances.

Conventional appliances include:

- ✧ Smart television
- ✧ Smart speaker
- ✧ Smart air conditioner
- ✧ Smart closetool
- ✧ Smart door lock
- ✧ Other smart home appliances

## 7.2. Home place application

For home, hotel, office, toilet and other places, this product on the place there is no movement target, personnel movement direction (close, far away), there is no personnel and other real-time detection, and then achieve security, electrical control, personnel monitoring and other functions. The scheme is highly sensitive and can effectively avoid privacy problems. Through the Internet of Things transmission methods and means, combined with the relevant Internet of Things support platform, to achieve the effective application of relevant places.

Typical application scenarios include:

- ✧ Home security
- ✧ Hotel management and monitoring
- ✧ Community health staff monitoring
- ✧ Office monitoring

## 7.3. Energy saving control application

Based on the functions of moving target detection and biometric detection, this product can be applied to energy saving control, the main scenarios are as follows:

- ✧ Energy saving of household appliances
- ✧ Office electrical energy saving control
- ✧ Street lamp energy-saving control

## 8. Announcements

### 8.1. Startup time

When the module is initially powered on, the internal registers need to be initialized and the ambient noise fully evaluated. Therefore, the stable startup time of the module is about 1s.

### 8.2. Effective detection range

The detection range of the radar module is related to the size of the target, the mode of movement, the use environment and other factors, so the actual detection range fluctuates within a certain range is a normal phenomenon.

### 8.3. Radar biological detection performance

Since human breathing and heartbeat are ultra-low frequency physical signs, and human body has weak reflection of radar signal compared with furniture and household appliances, radar occasional detection failure is a normal phenomenon.

## 8.4. Power

The requirement of radar module on power quality is higher than that of conventional low-frequency circuit. When supplying power to the module, ensure that there is no obvious burr or ripple in the power supply. In order to ensure the normal operation of the VCO circuit inside the module, the power input voltage range is 4.2V~5.4V, the power ripple should be within 100kHz without obvious spectral peak, and the peak current can support 180mA.

## 9. Common problem

**Interference factors:** Radar is an electromagnetic wave detection sensor, active inanimate experience will lead to false positives. Usually, the movement of objects such as electric fans, pets, vegetation, curtains, and motors inside air conditioners can cause misjudgments.

**Non-interfering factors:** Radar electromagnetic waves will penetrate human clothing, curtains, thin wood, glass.

## 10. Disclaimer

Try to be as accurate as possible at the time of publication. Considering the technical complexity of the product and the differences in the working environment, it is difficult to exclude some inaccurate or incomplete descriptions, so this document is for user reference only. Our company reserves the right to make changes to the product without notifying the user, and our company does not make any promises and guarantees in the legal sense. Encourage customers to make valuable comments on products and tools.

## 11. Change record

Date	Versions	Revise content
2023-11-18	V1.0	Original version
2023-11-24	V1.1	Modify the description of the default baud rate of the serial port

**Shenzhen Hi-Link Electronic Co., Ltd.**



**Address:** 17F, Building E, Xinghe WORLD, Minzhi Street, Long Hua district, Shenzhen 51813

**Email:** [sales@hlktech.com](mailto:sales@hlktech.com)

**Website:** [www.hlktech.net](http://www.hlktech.net)

# Other ManualsLib Projects



[www.manualslib.com](http://www.manualslib.com)



[www.manualslib.de](http://www.manualslib.de)



[www.manualslib.es](http://www.manualslib.es)



[www.manualslib.fr](http://www.manualslib.fr)



[www.manualslib.nl](http://www.manualslib.nl)



[www.manualslib.mx](http://www.manualslib.mx)



[www.manualslib.tech](http://www.manualslib.tech) 30+ Languages